

FISSAGGI CILINDRI PNEUMATICI

SERIE ISO 15552

TIPO 2801 | TIPO 2901



Cerniera femmina in lega leggera



Cerniera femmina in acciaio
(per alesaggi 32-200)

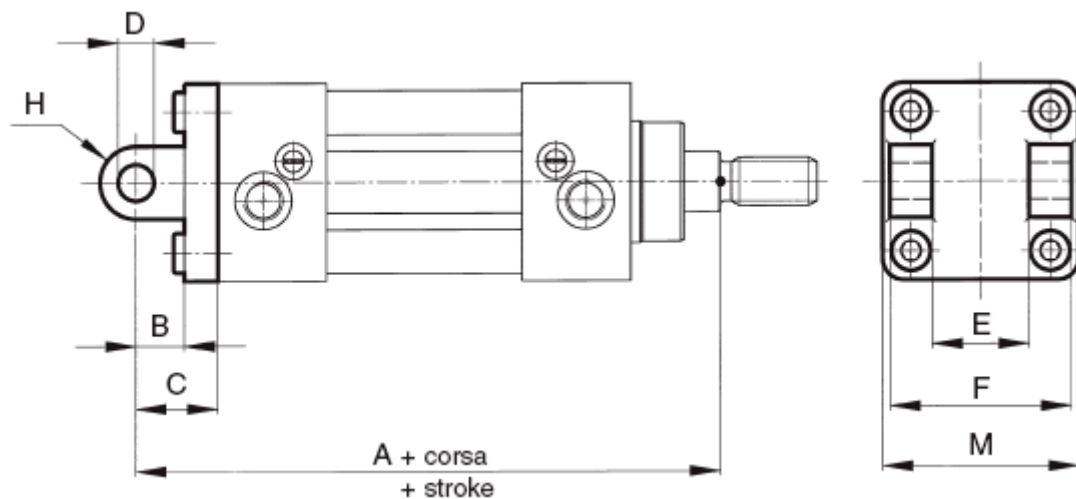

Alesaggio	A	B	C ±0,2	D H9	E H14	F h14	H	M	Vite di ancoraggio UNI 5931
32	142	13	22	10	26	45	10	45	M 6X18
40	160	16	25	12	28	52	12	52	M 6X18
50	170	16	27	12	32	60	12	65	M 8X25
63	190	21	32	16	40	70	16	75	M 8X25
80	210	22	36	16	50	90	16	95	M 10X30
100	230	27	41	20	60	110	20	115	M 10X30
125	275	30	50	25	70	130	25	140	M 12X35
160	315	35	55	30	90	170	30	180	M 16X30
200	335	35	60	30	90	170	30	220	M 16X30
250	375	45	70	40	110	200	40	270	M 20X30
320	420	50	80	45	120	220	45	350	M 20X30

TIPO 2803 | TIPO 2903



Contro supporto a 90° in lega leggera



Contro supporto a 90° in acciaio (per alesaggi 32-200)

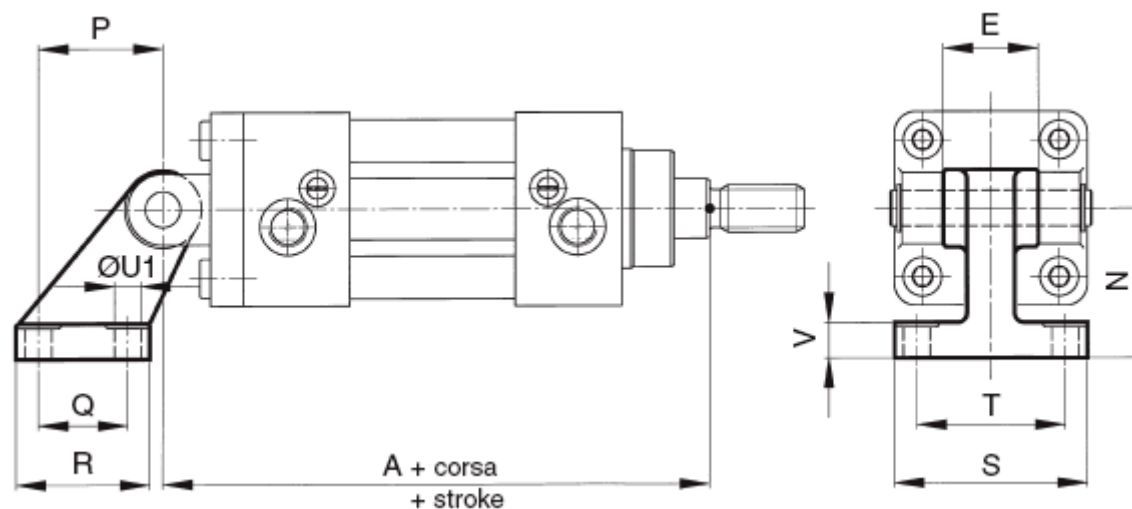

Alesaggio mm.	A	E	N Js 15	P Js 15	Q Js 14	R	S	T Js 14	U1	V
32	142	26	32	21	18	31	51	38	6.5	8
40	160	28	36	24	22	35	54	41	6.5	10
50	170	32	45	33	30	45	65	50	9	12
63	190	40	50	37	35	50	67	52	9	12
80	210	50	63	47	40	60	86	66	11	14
100	230	60	71	55	50	70	96	76	11	15
125	275	70	90	70	60	90	124	94	14	20
160	315	90	115	97	88	126	156	118	14	25
200	335	90	135	105	90	130	162	122	18	30
250	375	110	165	128	110	160	200	150	22	35
320	420	120	200	150	122	186	234	170	26	40



TIPO 2802 | TIPO 2902



Cerniera maschio in lega leggera



Cerniera maschio in acciaio
(per alesaggi 32-200)

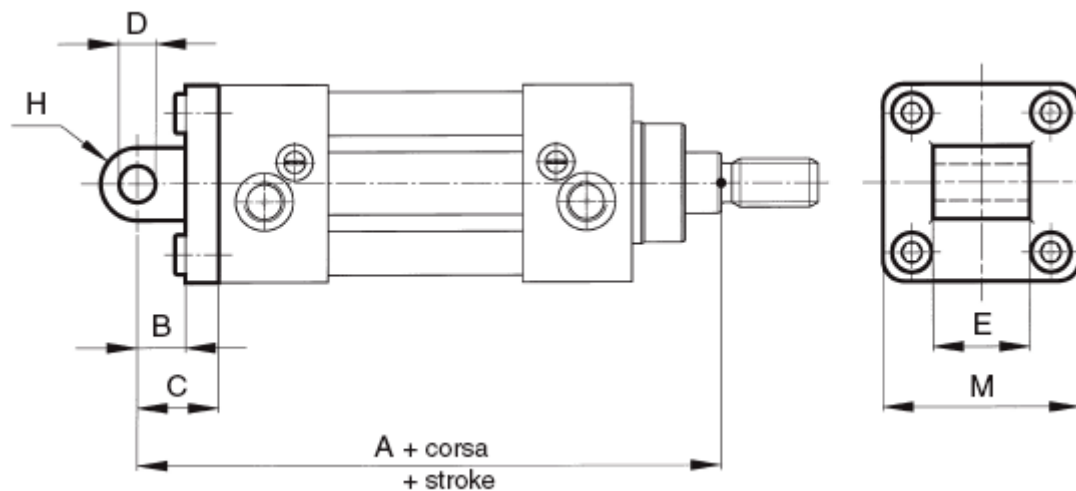

Alesaggio	A	B	C ±0,2	D H9	E	SERIE	H	M	Vite di ancoraggio UNI 5931
32	142	13	22	10	26	-0.2 -0.6	10	45	M 6X18
40	160	16	25	12	28		12	52	M 6X18
50	170	16	27	12	32		12	65	M 8X25
63	190	21	32	16	40		16	75	M 8X25
80	210	22	36	16	50		16	95	M 10X30
100	230	27	41	20	60		20	115	M 10X30
125	275	30	50	25	70	-0.5 -1.2	25	140	M 12X35
160	315	35	55	30	90		30	180	M 16X30
200	335	35	60	30	90		30	220	M 16X30
250	375	45	70	40	110		40	270	M 20X30
320	420	50	80	45	120		45	350	M 24X40



TIPO 2907



Flangia anteriore o posteriore
in acciaio zincato

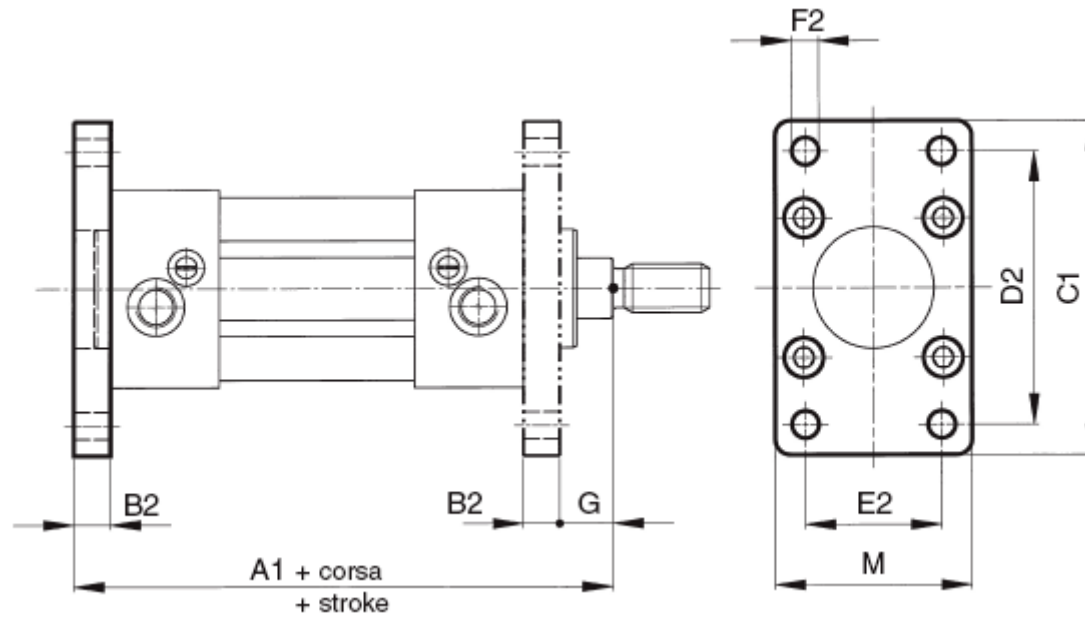

Alesaggio mm.	A1	B2 Js 14	C1	D2 Js 14	E2 Js 14	F2 H13	G	M	Vite di ancoraggio UNI 5931
32	130	10	80	64	32	7	16	45	M 6X18
40	145	10	90	72	36	9	20	52	M 6X18
50	155	12	110	90	45	9	25	65	M 8X20
63	170	12	120	100	50	9	25	75	M 8X20
80	190	16	150	126	63	12	30	95	M 10X20
100	205	16	170	150	75	14	35	115	M 10X20
125	145	20	205	180	90	16	45	140	M 12X30
160	280	20	260	230	115	18	60	180	M 16X30
200	300	25	310	270	135	22	70	220	M 16X30
250	330	25	390	330	165	26	80	270	M 20X30
320	370	30	460	400	200	33	90	350	M 24X40



TIPO 2908



Piedino basso in acciaio
zincato

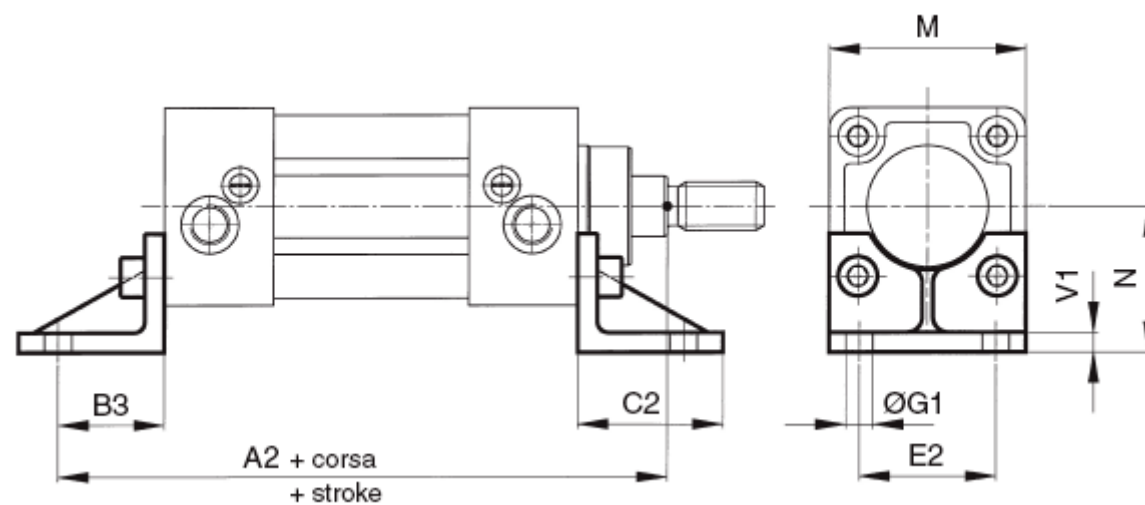

Alesaggio mm.	A2	B3 ±0,2	C2	E2 Js 14	G1 H13	M	N Js 15	V1	Vite di ancoraggio UNI 5931
32	144	24	35	32	7	45	32	3.5	M 6X18
40	163	28	36	36	9	52	36	3.5	M 6X18
50	175	32	45	45	9	65	45	3.5	M 8X20
63	190	32	45	50	9	75	50	4.5	M 8X20
80	215	41	55	63	12	95	63	5	M 10X25
100	230	41	56	75	14	115	71	5	M 10X25
125	270	45	68	90	16	140	90	9	M 12X35
160	320	60	80	115	18	180	115	12	M 16X30
200	345	70	85	135	22	220	135	12	M 16X30
250	380	75	100	165	26	270	165	20	M 20X40
320	425	85	120	200	35	350	200	23	M 24X45



TIPO 2909



Cerniera intermedia in ghisa o acciaio zincato

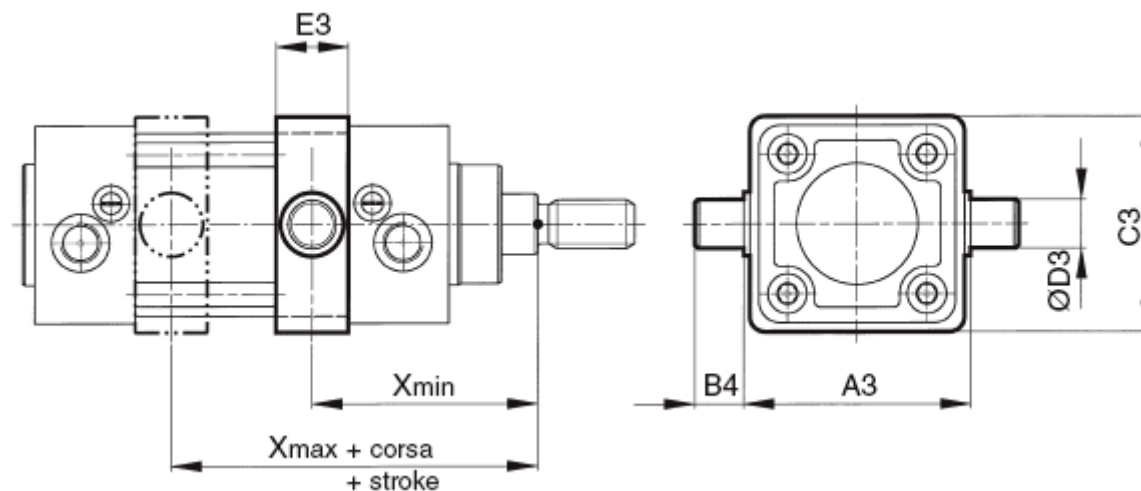

Alesaggio mm.	A3 h14	B4 h14	C3	D3 e9	E3	X min.	X max.
32	50	12	57	12	15	67	79
40	63	16	59	16	20	74	91
50	75	16	71	16	20	81	99
63	90	20	86	20	25	88	107
80	110	20	106	20	25	100	120
100	132	25	128	25	30	108	132
125	160	25	155	25	32	126	164
160	200	32	190	32	40	148	193
200	250	32	240	32	40	208	163
250	320	40	300	40	50	185	225
320	400	50	380	50	60	207	253



TIPO 2904



Cerniera a forcella in acciaio,
con perno di posizionamento

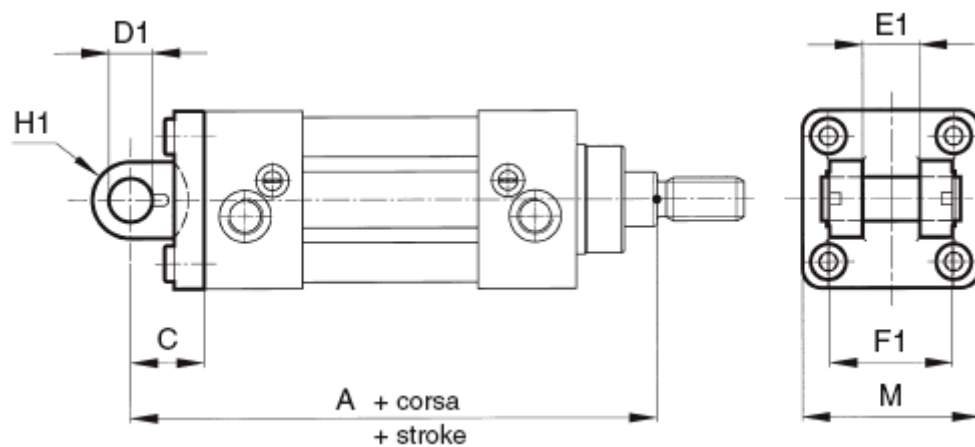

Alesaggio mm.	A	C ±0,2	D1 F7	E1 H14	F1 d12	H1 max	M	Viti di ancoraggio UNI 5931
32	142	22	10	14	34	11	45	M 6X18
40	160	25	12	16	40	13	55	M 6X18
50	170	27	16	21	45	18	65	M 8X20
63	190	32	16	21	51	18	75	M 8X20
80	210	36	20	25	65	22	95	M 1025
100	230	41	20	25	75	22	115	M 10X25
125	275	50	30	37	97	25	140	M 12X35



TIPO 2905



Cerniera maschio in acciaio
con snodo sferico DIN648K

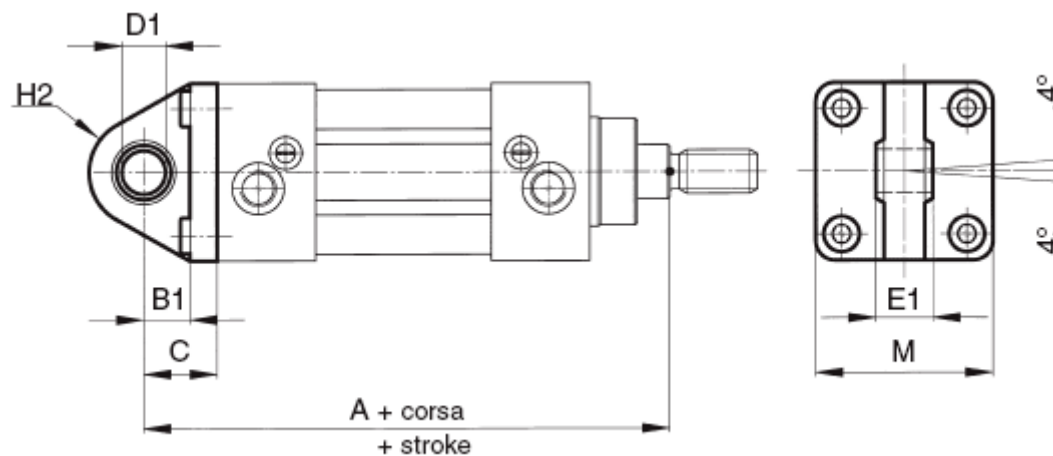

Alesaggio mm.	A	B1	C $\pm 0,2$	D1 H7	E1 -0,1	H2 max	M	Viti di ancoraggio UNI 5931
32	142	12	22	10	14	15	45	M 6X18
40	160	15	25	12	16	18	52	M 6X18
50	170	17	27	16	21	20	65	M 8X20
63	190	20	32	16	21	23	75	M 8X20
80	210	20	36	20	25	27	95	M 10X25
100	230	25	41	20	25	30	115	M 10X25
125	275	30	50	30	37	40	140	M 12X35



TIPO 2906



Contro supporto a 90° in
acciaio con snodo sferico 648K

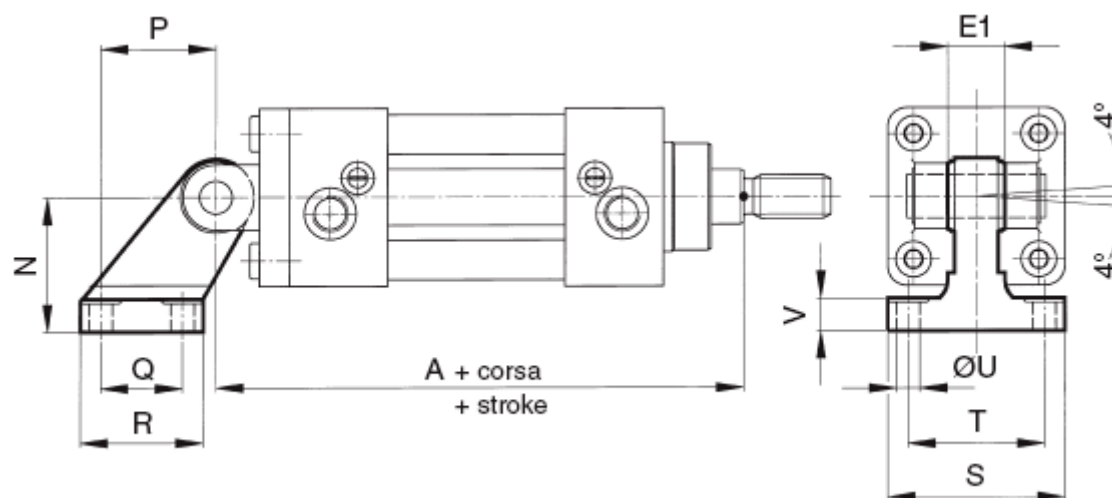

Alesaggio mm.	A	E1 -0,1	N Js 15	P Js 15	Q Js 14	R	S	T Js 14	U	V
32	142	14	32	21	18	31	51	38	6.5	8
40	160	16	36	24	22	35	5	41	6.5	10
50	170	21	45	33	30	45	64	50	8.5	12
63	190	21	50	37	35	50	67	52	8.5	12
80	210	25	63	47	40	60	86	66	10.5	14
100	230	25	71	55	50	70	96	76	10.5	15
125	275	37	90	70	60	90	124	94	13.5	20



TIPO IKK



Snodo di compensazione
radiale e assiale

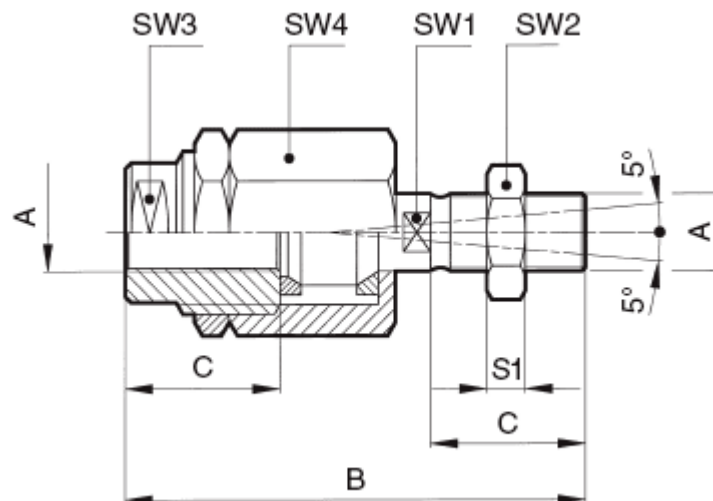

Alesaggio mm.	A	B	C	S1	SW1	SW2	SW3	SW4
32	M10X1,25	71	20	5	12	17	19	30
40	M12X1,25	75	24	6	12	19	19	30
50	M16X1,5	103	32	8	20	24	30	42
63	M16X1,5	103	32	8	20	24	30	42
80	M20X1,5	119	40	10	20	30	30	42
100	M20X1,5	119	40	10	20	30	30	42



TIPO SEC



Perno per cerniera tipo 2801-2901 in acciaio rettificato

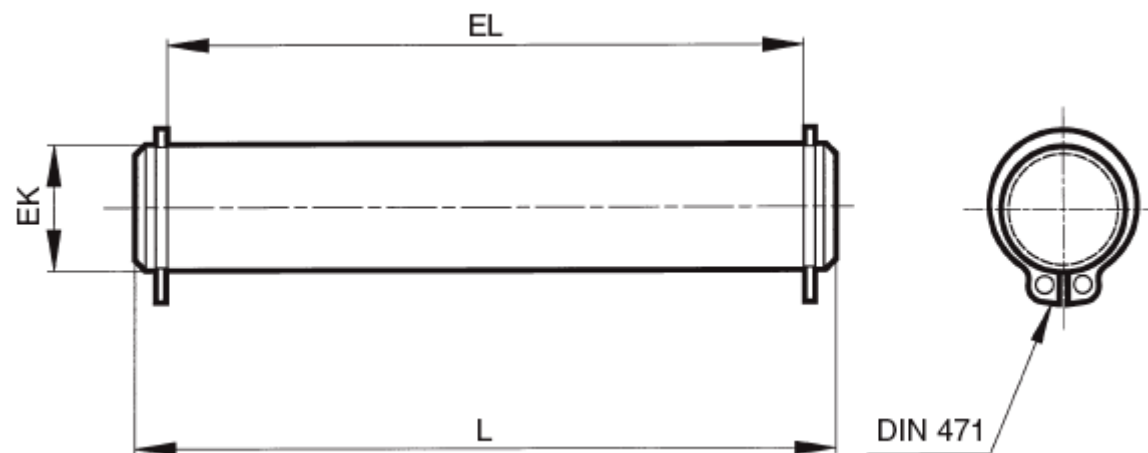

Alesaggio mm.	EK e8	EL	L
32	10	46	52
40	12	53	59
50	12	61	67
63	16	71	77
80	16	91	97
100	20	111	118
125	25	132	138
160	30	172	180
200	30	172	180
250	40	202	210
320	45	223	235



TIPO IFF



Forcella femmina in acciaio
zincato ISO 8140

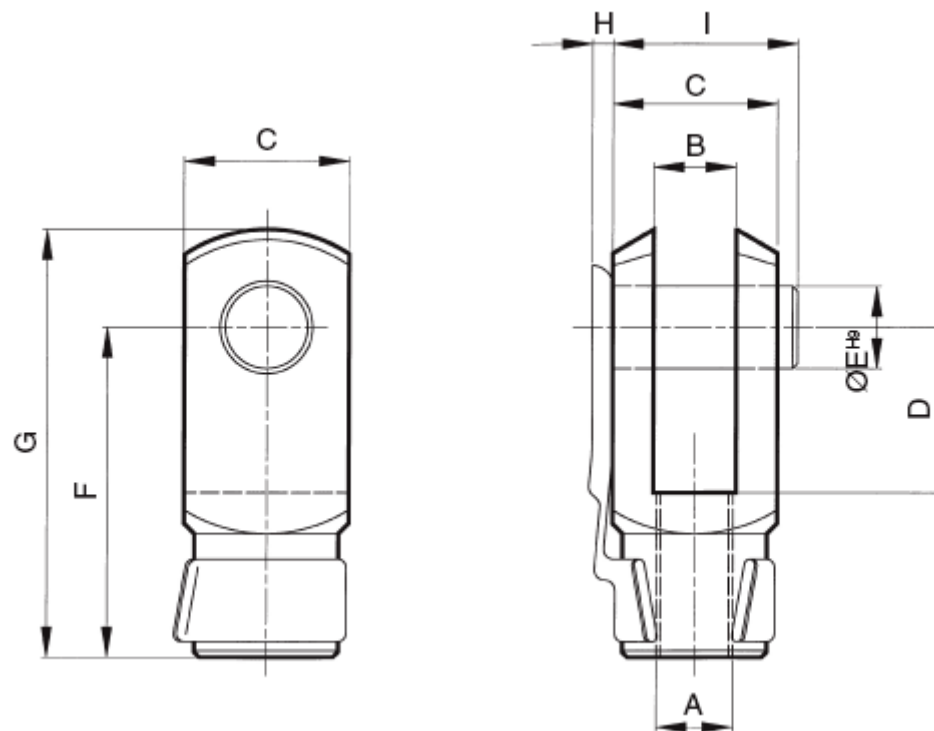

Alesaggio	A	B	C	D	E	F	G	H	I
32	M10X1,25	10	20	20	10	40	52	3	23
40	M12X1,25	12	24	24	12	48	62	4	28
50	M16X1,5	16	32	32	16	64	83	4	36
63	M16X1,5	16	32	32	16	64	83	4	36
80	M20X1,5	20	40	40	20	80	105	4	44
100	M20X1,5	20	40	40	20	80	105	4	44
125	M27X2	30	55	54	30	110	148	-	65
160	M36X2	35	70	72	35	144	188	-	84
200	M36X2	35	70	72	35	144	188	-	84
250	M42X2	40	85	84	40	168	232	-	96
320	M48X2	50	90	96	50	192	265	-	



TIPO IKJ



Forcella oscillante in acciaio
zincato ISO8139

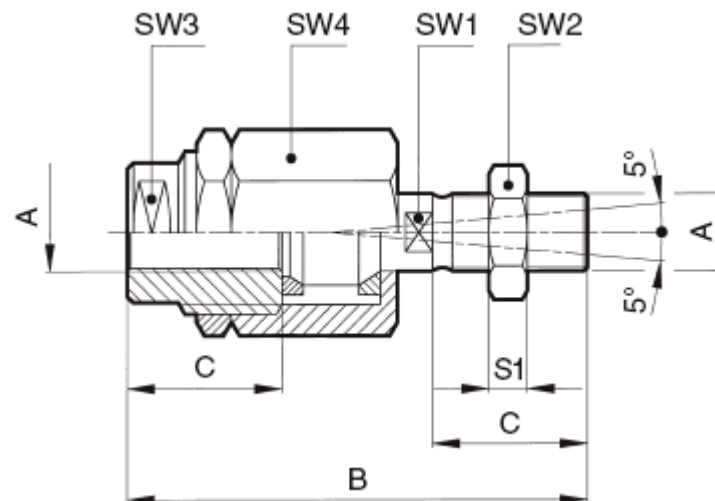

Alesaggio mm.	A	B	C	D	E	F	G	H	I	L
32	M10X1,25	20	17	43	57	28	10.5	14	10	12.9
40	M12X1,25	22	19	50	66	32	12	16	12	15.4
50	M16X1,5	28	22	64	85	42	15	21	16	19.3
63	M16X1,5	28	22	64	85	42	15	21	16	19.3
80	M20X1,5	33	30	77	102	50	18	25	20	24.3
100	M20X1,5	33	30	77	102	50	18	25	20	24.3
125	M27X2	51	41	110	145	40	5	37	30	34.8
160	M36X2	56	50	125	165	80	28	43	35	37.7
200	M36X2	56	50	125	165	80	28	43	35	37.7
250	M42X2	60	55	142	187	90	33	49	40	45.2
320	M48X2	65	65	160	218	116	45	60	50	58

